

# ***DAICEL CHIRAL COLUMNS***

vol.5

# PRODUCT LIST

DAICEL chiral HPLC columns are the most referenced chiral HPLC columns. Used for their high quality, broad selectivity and high loading capacities, they separate > 99% of all racemic compounds.

Column name	Separation compounds	Mobile phases	Page
<b>Immobilized type</b> CHIRALPAK® IA-3/IA CHIRALPAK® ID-3/ID CHIRALPAK® IB-3/IB CHIRALPAK® IE-3/IE CHIRALPAK® IC-3/IC CHIRALPAK® IF-3/IF		THF, Acetic ether, CHCl <sub>3</sub> , Hexane, IPA, EtOH etc.	p1-4
<b>Normal Phase</b> CHIRALPAK® AD-3/AD-H/AD CHIRALPAK® AS-3/AS-H/AS CHIRALPAK® AY-3/AY-H CHIRALPAK® AZ-3/AZ-H CHIRALCEL® OD-3/OD-H/OD CHIRALCEL® OJ-3/OJ-H/OJ CHIRALCEL® OX-3/OX-H CHIRALCEL® OZ-3/OZ-H CHIRALCEL® OB-H/OB CHIRALCEL® OC-H/OC CHIRALCEL® OA CHIRALCEL® OF CHIRALCEL® OG CHIRALCEL® OJ CHIRALCEL® OK	Amide group Aromatic compounds Carbonyl group Nitro group Sulfonyl group Cyano group Hydroxyl group Amino group Carbonic acids Amino acid derivatives	Hexane/IPA Hexane/EtOH etc.	p6-16
<b>Reverse Phase</b> CHIRALPAK® AD-3R/AD-RH CHIRALPAK® AS-3R/AS-RH CHIRALPAK® AY-3R/AY-RH CHIRALPAK® AZ-3R/AZ-RH CHIRALCEL® OD-3R/OD-RH/OD-R CHIRALCEL® OJ-3R/OJ-RH CHIRALCEL® OX-3R/OX-RH CHIRALCEL® OZ-3R/OZ-RH		Water and buffer Water/Acetonitrile  Water/Methanol	p18-22
<b>Protein-based Chiral HPLC column</b> CHIRALPAK AGP® CHIRALPAK CBH CHIRALPAK HSA	Amnes (primary, secondary, tertiary, and quaternary) Acids (strong and weak) Nonprotolytes (amides, esters, alcohols, sulfoxides, etc.)	(Water base)	p23-25
<b>Crown ether type</b> CROWNPAK® CR(+) CROWNPAK® CR(-)	Amino acids Primary amino group	Perchloric solution	p26-28
<b>Anion-exchange type</b> CHIRALPAK® QN-AX CHIRALPAK® QD-AX	Compounds with acidic functions	Methanol Acetonitrile	
<b>Ligand-exchange type</b> CHIRALPAK® WH CHIRALPAK® MA(+)	Amino acids or amino acid derivatives Hydroxycarbonic acids	Cupric sulfate solution	
<b>Polymethacrylate type</b> CHIRALPAK® OP(+) CHIRALPAK® OT(+)	Aromatic compounds	Hexane/IPA Methanol	

## CAUTION

Please follow the below points for maximum column life.

- (1) Please use carefully to avoid any shock. Flow rate direction is indicated on the column label.
- (2) Operating a column in accordance with the instruction manual will result in a long column life.  
The instruction sheet is not applicable to any other DAICEL columns.
- (3) The use of guard cartridge or guard column is highly recommended.

# CONTENTS

## DAICEL CHIRAL COLUMNS PRODUCT LIST

### CHIRAL HPLC COLUMNS

#### Immobilized type Chiral HPLC Columns

CHIRALPAK® IA-3/IA      CHIRALPAK® ID-3/ID  
CHIRALPAK® IB-3/IB      CHIRALPAK® IE-3/IE  
CHIRALPAK® IC-3/IC      CHIRALPAK® IF-3/IF

#### Normal Phase HPLC Columns

CHIRALPAK® AD-3/AD-H/AD  
CHIRALPAK® AS-3/AS-H/AS  
CHIRALPAK® AY-3/AY-H  
CHIRALPAK® AZ-3/AZ-H  
CHIRALCEL® OD-3/OD-H/OD  
CHIRALCEL® OJ-3/OJ-H/OJ  
CHIRALCEL® OX-3/OX-H  
CHIRALCEL® OZ-3/OZ-H  
Others

#### Reverse Phase HPLC Columns

CHIRALPAK® AD-3R/AD-RH  
CHIRALPAK® AS-3R/AS-RH  
CHIRALPAK® AY-3R/AY-RH  
CHIRALPAK® AZ-3R/AZ-RH  
CHIRALCEL® OD-3R/OD-RH/OD-R  
CHIRALCEL® OJ-3R/OJ-RH  
CHIRALCEL® OX-3R/OX-RH  
CHIRALCEL® OZ-3R/OZ-RH

#### Protein-based Chiral HPLC Columns

CHIRALPAK AGP®  
CHIRALPAK CBH  
CHIRALPAK HSA

#### DAICEL Chiral HPLC Columns for Special Applications

CROWNPAK® CR(+)/CR(-)  
Crown ether HPLC columns for separation in acidic mobile phase

CHIRALPAK® QN-AX/QD-AX  
Anion-exchange HPLC columns for separation of chiral acids

CHIRALPAK® WH/CHIRALPAK MA(+)  
Ligand-exchange HPLC columns designed for amino-acids separations

CHIRALPAK® OP(+)/OT(+)  
Polymethacrylate HPLC columns

#### Analytical Chromatography Accessories

Guard Cartridge Holder  
Column Jacket

#### SFC Chiral Columns



Immobilized type Chiral HPLC Columns

Normal Phase HPLC Columns

Reverse Phase HPLC Columns

Protein-based Chiral HPLC Columns

DAICEL Chiral HPLC Columns for Special Applications

Analytical Chromatography Accessories

SFC Chiral Columns

1 4

6 17

18 22

23 25

26 28

29

30 32

# Immobilized type Chiral HPLC Columns

## Feature

Immobilized columns are designed for solvent flexibility for the resolution of compounds with limited solubility, outstanding solvent tolerance and excellent separations of enantiomers.

- High efficiency separation
- Comatible with organic solvents which give higher sample solubility as mobile phase
- More possibility for successful baseline separation
- More simple work for sample separation

## Mobile Phase

You can use all kinds of solvents usable for ODS chromatography on Immobilized type chiral HPLC columns.

Hexane	Acetone	
IPA	MTBE	
EtOH	Ethyl acetate	
MeOH	CH <sub>2</sub> Cl <sub>2</sub>	
THF	Acetonitrile	
CHCl <sub>3</sub>	DMSO	
1,4-Dioxane	Water	etc.

※ Immobilized type columns are applicable to reverse phase.

## Reference

### CHIRALPAK® IA

Solvent versatility of immobilized 3,5-dimethylphenylcarbamate of amylose in enantiomeric separations by HPLC  
Journal of Chromatography A, 1075 (2005) 65-75

### CHIRALPAK® IB

Cellulose 3,5-dimethylphenylcarbamate immobilized on silica:  
A new chiral stationary phase for the analysis of enantiomers  
Analytica Chimica Acta 557 (2006) 221-228

### CHIRALPAK® IC

Cellulose tris(3,5-dichlorophenylcarbamate) immobilised on silica:  
A novel chiral stationary phase for resolution of enantiomers  
Journal of Pharmaceutical and Biomedical Analysis 46 (2008) 882-891

### Screening with immobilized type columns.

Common approaches for efficient method development with immobilised polysaccharide-derived chiral stationary phases  
Journal of Chromatography B, 875 (2008) 48-56

Enantiomer resolution screening strategy using multiple immobilised polysaccharide-based chiral stationary phases  
Journal of Chromatography A, 1191 (2008) 214-222

# CHIRALPAK® IA-3

## Immobilized type column of CHIRALPAK® AD-3

		Internal Diameter (mm)	Column Length (mm)	Particle Size (μm)	Reference
CHIRALPAK® IA-3	Analytical	2.1	150	3	80594
CHIRALPAK® IA-3	Analytical	2.1	250	3	80595
CHIRALPAK® IA-3	Analytical	4.6	50	3	80522
CHIRALPAK® IA-3	Analytical	4.6	100	3	80523
CHIRALPAK® IA-3	Analytical	4.6	150	3	80524
CHIRALPAK® IA-3	Analytical	4.6	250	3	80525
CHIRALPAK® IA-3	Guard Cartridges <sup>※1</sup>	4	10	3	80511

※1 : 3pc/set (You need Cartridge Holder when using Guard Cartridge.)

# CHIRALPAK® IA

## Immobilized type column of CHIRALPAK® AD-H

		Internal Diameter (mm)	Column Length (mm)	Particle Size (μm)	Reference
CHIRALPAK® IA	Analytical	2.1	150	5	80394
CHIRALPAK® IA	Analytical	2.1	250	5	80395
CHIRALPAK® IA	Analytical	4.6	150	5	80324
CHIRALPAK® IA	Analytical	4.6	250	5	80325
CHIRALPAK® IA	Guard Cartridges <sup>※1</sup>	4	10	5	80311
CHIRALPAK® IA	Semi-prep	10	250	5	80335
CHIRALPAK® IA	Semi-prep	20	250	5	80345
CHIRALPAK® IA	Guard column for Semi-prep	10	20	5	80337
CHIRALPAK® IA	Prep	50	500	20	80256
CHIRALPAK® IA	Guard column for Prep	50	100	20	80253

※1 : 3pc/set (You need Cartridge Holder when using Guard Cartridge.)

# CHIRALPAK® IB-3

## Immobilized type column of CHIRALCEL® OD-3

		Internal Diameter (mm)	Column Length (mm)	Particle Size (μm)	Reference
CHIRALPAK® IB-3	Analytical	2.1	150	3	81594
CHIRALPAK® IB-3	Analytical	2.1	250	3	81595
CHIRALPAK® IB-3	Analytical	4.6	50	3	81522
CHIRALPAK® IB-3	Analytical	4.6	100	3	81523
CHIRALPAK® IB-3	Analytical	4.6	150	3	81524
CHIRALPAK® IB-3	Analytical	4.6	250	3	81525
CHIRALPAK® IB-3	Guard Cartridges <sup>※1</sup>	4	10	3	81511

※1 : 3pc/set (You need Cartridge Holder when using Guard Cartridge.)

# CHIRALPAK® IB

## Immobilized type column of CHIRALCEL® OD-H

		Internal Diameter (mm)	Column Length (mm)	Particle Size (μm)	Reference
CHIRALPAK® IB	Analytical	2.1	150	5	81394
CHIRALPAK® IB	Analytical	2.1	250	5	81395
CHIRALPAK® IB	Analytical	4.6	150	5	81324
CHIRALPAK® IB	Analytical	4.6	250	5	81325
CHIRALPAK® IB	Guard Cartridges <sup>※1</sup>	4	10	5	81311
CHIRALPAK® IB	Semi-prep	10	250	5	81335
CHIRALPAK® IB	Semi-prep	20	250	5	81345
CHIRALPAK® IB	Guard column for Semi-prep	10	20	5	81337

※1 : 3pc/set (You need Cartridge Holder when using Guard Cartridge.)

### CSP

Amylose tris  
(3,5-dimethylphenylcarbamate)  
immobilized to silica gel

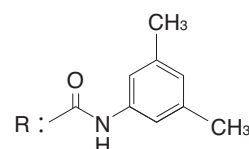
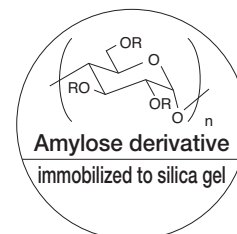

### CSP

Cellulose tris  
(3,5-dimethylphenylcarbamate)  
immobilized to silica gel

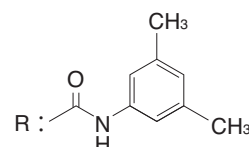
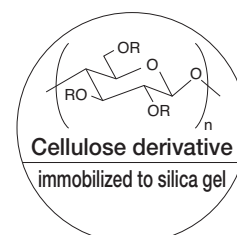

# Immobilized type Chiral HPLC Columns

## CHIRALPAK® IC-3

Immobilized type column of new chiral selector

		Internal Diameter (mm)	Column Length (mm)	Particle Size (μm)	Reference
CHIRALPAK® IC-3	Analytical	2.1	150	3	83594
CHIRALPAK® IC-3	Analytical	2.1	250	3	83595
CHIRALPAK® IC-3	Analytical	4.6	50	3	83522
CHIRALPAK® IC-3	Analytical	4.6	100	3	83523
CHIRALPAK® IC-3	Analytical	4.6	150	3	83524
CHIRALPAK® IC-3	Analytical	4.6	250	3	83525
CHIRALPAK® IC-3	Guard Cartridges <sup>※1</sup>	4	10	3	83511

※1 : 3pc/set (You need Cartridge Holder when using Guard Cartridge.)

## CHIRALPAK® IC

Immobilized type column of new chiral selector

		Internal Diameter (mm)	Column Length (mm)	Particle Size (μm)	Reference
CHIRALPAK® IC	Analytical	2.1	150	5	83394
CHIRALPAK® IC	Analytical	2.1	250	5	83395
CHIRALPAK® IC	Analytical	4.6	150	5	83324
CHIRALPAK® IC	Analytical	4.6	250	5	83325
CHIRALPAK® IC	Guard Cartridge <sup>※1</sup>	4	10	5	83311
CHIRALPAK® IC	Semi-prep	10	250	5	83335
CHIRALPAK® IC	Semi-prep	20	250	5	83345
CHIRALPAK® IC	Guard column for Semi-prep	10	20	5	83337
CHIRALPAK® IC	Prep	50	500	20	83256
CHIRALPAK® IC	Guard column for Prep	50	100	20	83253

※1 : 3pc/set (You need Cartridge Holder when using Guard Cartridge.)

## CHIRALPAK® ID-3

Immobilized type column of new chiral selector

		Internal Diameter (mm)	Column Length (mm)	Particle Size (μm)	Reference
CHIRALPAK® ID-3	Analytical	2.1	250	3	84595
CHIRALPAK® ID-3	Analytical	2.1	150	3	84594
CHIRALPAK® ID-3	Analytical	4.6	250	3	84525
CHIRALPAK® ID-3	Analytical	4.6	150	3	84524
CHIRALPAK® ID-3	Analytical	4.6	100	3	84523
CHIRALPAK® ID-3	Analytical	4.6	50	3	84522
CHIRALPAK® ID-3	Guard Cartridge ×3pcs	4	10	3	84511

## CHIRALPAK® ID

Immobilized type column of new chiral selector

		Internal Diameter (mm)	Column Length (mm)	Particle Size (μm)	Reference
CHIRALPAK® ID	Analytical	2.1	250	5	84395
CHIRALPAK® ID	Analytical	2.1	150	5	84394
CHIRALPAK® ID	Semi-preparative	20	250	5	84345
CHIRALPAK® ID	Semi-preparative	10	250	5	84335
CHIRALPAK® ID	Guard/semi prep	10	20	5	84337
CHIRALPAK® ID	Analytical	4.6	250	5	84325
CHIRALPAK® ID	Analytical	4.6	150	5	84324
CHIRALPAK® ID	Guard Cartridge ×3pcs	4	10	5	84311

CSP

Cellulose tris  
(3,5-dichlorophenylcarbamate)  
immobilized to silica gel

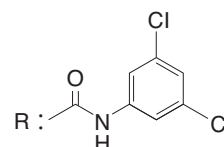
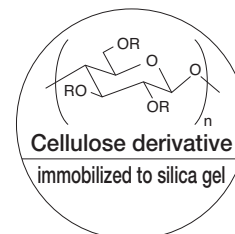

CSP

Amylose tris  
(3-chlorophenylcarbamate)  
immobilized to silica gel

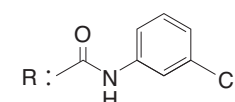
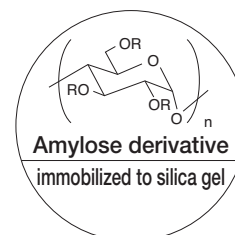

## CHIRALPAK® IE-3

### Immobilized type column of new chiral selector

		Internal Diameter (mm)	Column Length (mm)	Particle Size (μm)	Reference
CHIRALPAK® IE-3	Analytical	2.1	250	3	85595
CHIRALPAK® IE-3	Analytical	2.1	150	3	85594
CHIRALPAK® IE-3	Analytical	4.6	250	3	85525
CHIRALPAK® IE-3	Analytical	4.6	150	3	85524
CHIRALPAK® IE-3	Analytical	4.6	100	3	85523
CHIRALPAK® IE-3	Analytical	4.6	50	3	85522
CHIRALPAK® IE-3	Guard Cartridge ×3pcs	4	10	3	85511

## CHIRALPAK® IE

### Immobilized type column of new chiral selector

		Internal Diameter (mm)	Column Length (mm)	Particle Size (μm)	Reference
CHIRALPAK® IE	Analytical	2.1	250	5	85395
CHIRALPAK® IE	Analytical	2.1	150	5	85394
CHIRALPAK® IE	Semi-preparative	20	250	5	85345
CHIRALPAK® IE	Semi-preparative	10	250	5	85335
CHIRALPAK® IE	Guard/semi prep	10	20	5	85337
CHIRALPAK® IE	Analytical	4.6	250	5	85325
CHIRALPAK® IE	Analytical	4.6	150	5	85324
CHIRALPAK® IE	Guard Cartridge ×3pcs	4	10	5	85311

**CSP**  
 Amylose tris  
 (3,5-dichlorophenylcarbamate)  
 immobilized to silica gel

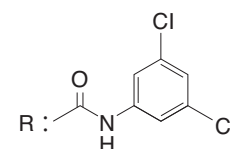
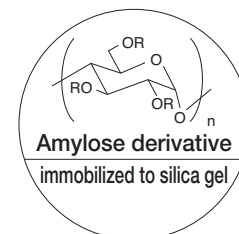

## CHIRALPAK® IF-3

### Immobilized type column of new chiral selector

		Internal Diameter (mm)	Column Length (mm)	Particle Size (μm)	Reference
CHIRALPAK® IF-3	Analytical	2.1	250	3	86595
CHIRALPAK® IF-3	Analytical	2.1	150	3	86594
CHIRALPAK® IF-3	Analytical	4.6	250	3	86525
CHIRALPAK® IF-3	Analytical	4.6	150	3	86524
CHIRALPAK® IF-3	Analytical	4.6	100	3	86523
CHIRALPAK® IF-3	Analytical	4.6	50	3	86522
CHIRALPAK® IF-3	Guard Cartridge ×3pcs	4	10	3	86511

**CSP**  
 Amylose tris  
 (3-chloro-4-methylphenylcarbamate)  
 immobilized to silica gel

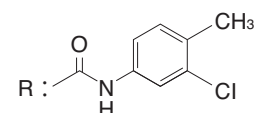
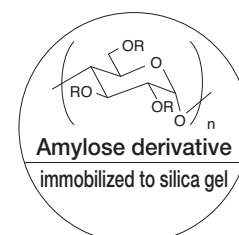

## CHIRALPAK® IF

### Immobilized type column of new chiral selector

		Internal Diameter (mm)	Column Length (mm)	Particle Size (μm)	Reference
CHIRALPAK® IF	Analytical	2.1	250	5	86395
CHIRALPAK® IF	Analytical	2.1	150	5	86394
CHIRALPAK® IF	Semi-preparative	20	250	5	86345
CHIRALPAK® IF	Semi-preparative	10	250	5	86335
CHIRALPAK® IF	Guard/semi prep	10	20	5	86337
CHIRALPAK® IF	Analytical	4.6	250	5	86325
CHIRALPAK® IF	Analytical	4.6	150	5	86324
CHIRALPAK® IF	Guard Cartridge ×3pcs	4	10	5	86311





# Normal Phase HPLC Columns

## Feature

- Polyssacharide-based chiral stationary phases (CSPs) are most widely used for chiral separation in the world. More than 80% of enantiomers can be separated with our polysaccharide-based chiral columns.
- We prepare various size of columns from Semi-micro to Preparative type.
- We provide 3 micron series of various type of Normal Phase chiral columns.

## Mobile Phase

### ① Standard solvent mixtures

	Hexane / 2-propanol	Hexane / EtOH
<b>CHIRALPAK® AD-3 / AD-H / AD</b> ※1 <b>CHIRALPAK® AS-3 / AS-H / AS</b> <b>CHIRALPAK® AY-3 / AY-H</b> <b>CHIRALPAK® AZ-3 / AZ-H</b> <b>CHIRALCEL® OD-3 / OD-H / OD</b> <b>CHIRALCEL® OJ-3 / OJ-H / OJ</b> <b>CHIRALCEL® OX-3 / OX-H</b> <b>CHIRALCEL® OZ-3 / OZ-H</b>	100/0 ~ 0/100	100/0 ~ 0/100 ※1

※1 : In cast of AD, the range Hexane/EtOH 85/15~40/60 may adversely affect baseline stability due to polymer leakage.

To safely transfer the column from 15%EtOH to 60%EtOH, it is strongly recommended to use 100% 2-propanol as a transition mobile phase at a low flow rate (high viscosity of 2-propanol).

- The retention is generally shorter with Ethanol than with 2-propanol.
  - The retention is generally shorter with a higher alcohol content.
  - The use of other alcohols such as 1-propanol, 1-BuOH, 2-BuOH etc... is possible, but effectiveness cannot be guaranteed.
- Do not use mobile phases containing more than 15% of these alcohols.

### ② Polar solvents

<b>CHIRALPAK® AD-3 / AD-H / AD</b> ※1 <b>CHIRALPAK® AS-3 / AS-H / AS</b> <b>CHIRALPAK® AY-3 / AY-H</b> <b>CHIRALCEL® OD-3 / OD-H / OD</b> <b>CHIRALCEL® OJ-3 / OJ-H / OJ</b> <b>CHIRALCEL® OZ-3 / OZ-H</b>	MeOH	EtOH	2-propanol	Acetonitrile
---	------	------	------------	--------------

※1 : The use of polar solvents as 100% methanol or 100% acetonitrile is possible with CHIRALPAK® AD column. Nevertheless once the column is transferred to a polar mode it should be dedicated to this specific application.

Please read carefully the column instruction manual specific to each stationary phase for mobile additives and solvent compatibility.

## Notice

DAICEL coated polysaccharide chiral stationary phases are made with a spherical high quality silica support onto which the polymeric chiral selector (amylosic derivatives, cellulosic derivatives,) is physically coated. Due to the coated nature of these chiral support, solvents should be carefully selected. Please read carefully the column instruction manual specific to each column for mobile phase additives and solvent compatibility.

The following solvents should never be used.

DMF, DMSO, Dioxane, Toluene, THF, Chloroform, Methylene, Chloride, Acetone, Ethyl acetate.

# Normal Phase HPLC Columns

## CHIRALPAK® AD-3

		Internal Diameter (mm)	Column Length (mm)	Particle Size (μm)	Reference
CHIRALPAK® AD-3	Analytical	2.1	150	3	19594
CHIRALPAK® AD-3	Analytical	2.1	250	3	19595
CHIRALPAK® AD-3	Analytical	4.6	50	3	19522
CHIRALPAK® AD-3	Analytical	4.6	100	3	19523
CHIRALPAK® AD-3	Analytical	4.6	150	3	19524
CHIRALPAK® AD-3	Analytical	4.6	250	3	19525
CHIRALPAK® AD-3	Guard Cartridges <sup>※1</sup>	4	10	3	19511

※1 : 3pc/set (You need Cartridge Holder when using Guard Cartridge.)

## CHIRALPAK® AD-H

		Internal Diameter (mm)	Column Length (mm)	Particle Size (μm)	Reference
CHIRALPAK® AD-H	Analytical	2.1	150	5	19394
CHIRALPAK® AD-H	Analytical	2.1	250	5	19395
CHIRALPAK® AD-H	Analytical	4.6	150	5	19324
CHIRALPAK® AD-H	Analytical	4.6	250	5	19325
CHIRALPAK® AD-H	Guard Cartridges <sup>※1</sup>	4	10	5	19311
CHIRALPAK® AD-H	Semi-prep	10	250	5	19335
CHIRALPAK® AD-H	Semi-prep	20	250	5	19345
CHIRALPAK® AD-H	Guard column for Semi-prep	10	20	5	19337

※1 : 3pc/set (You need Cartridge Holder when using Guard Cartridge.)

## CHIRALPAK® AD

		Internal Diameter (mm)	Column Length (mm)	Particle Size (μm)	Reference
CHIRALPAK® AD	Analytical	4.6	250	10	19025
CHIRALPAK® AD	Guard column for Analytical	4.6	50	10	19022
CHIRALPAK® AD	Semi-prep	10	250	10	19035
CHIRALPAK® AD	Guard column for Semi-prep	10	50	10	19032
CHIRALPAK® AD	Semi-prep	20	250	10	19045
CHIRALPAK® AD	Guard column for Semi-prep	20	50	10	19042
CHIRALPAK® AD	Prep	50	500	20	19256
CHIRALPAK® AD	Guard column for Prep	50	100	20	19253

### CSP

Amylose tris  
(3,5-dimethylphenylcarbamate)  
coated on silica gel

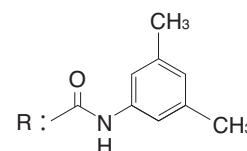
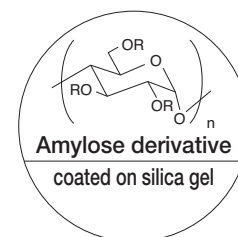

## CHIRALPAK® AS-3

		Internal Diameter (mm)	Column Length (mm)	Particle Size (μm)	Reference
CHIRALPAK® AS-3	Analytical	2.1	150	3	20594
CHIRALPAK® AS-3	Analytical	2.1	250	3	20595
CHIRALPAK® AS-3	Analytical	4.6	50	3	20522
CHIRALPAK® AS-3	Analytical	4.6	100	3	20523
CHIRALPAK® AS-3	Analytical	4.6	150	3	20524
CHIRALPAK® AS-3	Analytical	4.6	250	3	20525
CHIRALPAK® AS-3	Guard Cartridges <sup>※1</sup>	4	10	3	20511

※1 : 3pc/set (You need Cartridge Holder when using Guard Cartridge.)

## CHIRALPAK® AS-H

		Internal Diameter (mm)	Column Length (mm)	Particle Size (μm)	Reference
CHIRALPAK® AS-H	Analytical	2.1	150	5	20394
CHIRALPAK® AS-H	Analytical	2.1	250	5	20395
CHIRALPAK® AS-H	Analytical	4.6	150	5	20324
CHIRALPAK® AS-H	Analytical	4.6	250	5	20325
CHIRALPAK® AS-H	Guard cartridges <sup>※1</sup>	4	10	5	20311
CHIRALPAK® AS-H	Semi-prep	10	250	5	20335
CHIRALPAK® AS-H	Semi-prep	20	250	5	20345
CHIRALPAK® AS-H	Guard column for Semi-prep	10	20	5	20337

※1 : 3pc/set (You need Cartridge Holder when using Guard Cartridge.)

## CHIRALPAK® AS

		Internal Diameter (mm)	Column Length (mm)	Particle Size (μm)	Reference
CHIRALPAK® AS	Analytical	4.6	250	10	20025
CHIRALPAK® AS	Guard column for Analytical	4.6	50	10	20022
CHIRALPAK® AS	Semi-prep	10	250	10	20035
CHIRALPAK® AS	Guard column for Semi-prep	10	50	10	20032
CHIRALPAK® AS	Semi-prep	20	250	10	20045
CHIRALPAK® AS	Guard column for Semi-prep	20	50	10	20042
CHIRALPAK® AS	Prep	50	500	20	20256
CHIRALPAK® AS	Guard column for Prep	50	100	20	20253

### CSP

Amylose tris  
{ (S)- $\alpha$ -methylbenzylcarbamate }  
coated on silica gel

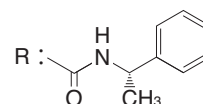
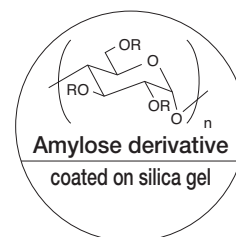

# Normal Phase HPLC Columns

## CHIRALPAK® AY-3

		Internal Diameter (mm)	Column Length (mm)	Particle Size (µm)	Reference
CHIRALPAK® AY-3	Analytical	2.1	150	3	47594
CHIRALPAK® AY-3	Analytical	2.1	250	3	47595
CHIRALPAK® AY-3	Analytical	4.6	50	3	47522
CHIRALPAK® AY-3	Analytical	4.6	100	3	47523
CHIRALPAK® AY-3	Analytical	4.6	150	3	47524
CHIRALPAK® AY-3	Analytical	4.6	250	3	47525
CHIRALPAK® AY-3	Guard Cartridges**1	4	10	3	47511

\*\*1 : 3pc/set (You need Cartridge Holder when using Guard Cartridge.)

## CHIRALPAK® AY-H

		Internal Diameter (mm)	Column Length (mm)	Particle Size (µm)	Reference
CHIRALPAK® AY-H	Analytical	2.1	150	5	47394
CHIRALPAK® AY-H	Analytical	2.1	250	5	47395
CHIRALPAK® AY-H	Analytical	4.6	150	5	47324
CHIRALPAK® AY-H	Analytical	4.6	250	5	47325
CHIRALPAK® AY-H	Guard Cartridges**1	4	10	5	47311
CHIRALPAK® AY-H	Semi-prep	10	250	5	47335
CHIRALPAK® AY-H	Semi-prep	20	250	5	47345
CHIRALPAK® AY-H	Guard column for Semi-prep	10	20	5	47337

\*\*1 : 3pc/set (You need Cartridge Holder when using Guard Cartridge.)

### CSP

Amylose tris  
(5-chloro-2-methylphenylcarbamate)  
coated on silica gel

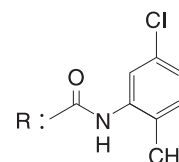
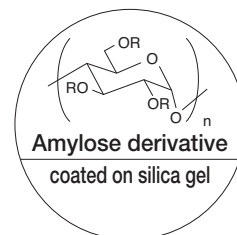

# CHIRALPAK® AZ-3

		Internal Diameter (mm)	Column Length (mm)	Particle Size (µm)	Reference
CHIRALPAK® AZ-3	Analytical	2.1	250	3	61595
CHIRALPAK® AZ-3	Analytical	2.1	150	3	61594
CHIRALPAK® AZ-3	Analytical	4.6	250	3	61525
CHIRALPAK® AZ-3	Analytical	4.6	150	3	61524
CHIRALPAK® AZ-3	Analytical	4.6	100	3	61523
CHIRALPAK® AZ-3	Analytical	4.6	50	3	61522
CHIRALPAK® AZ-3	Guard Cartridge ×3pcs	4	10	3	61511

## CSP

Amylose tris  
(3-chloro-4-methylphenylcarbamate)  
coated on silica gel

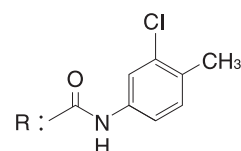
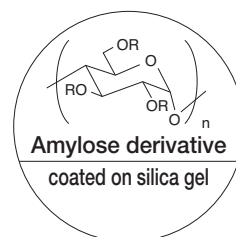

# CHIRALPAK® AZ-H

		Internal Diameter (mm)	Column Length (mm)	Particle Size (µm)	Reference
CHIRALPAK® AZ-H	Analytical	2.1	250	5	61395
CHIRALPAK® AZ-H	Analytical	2.1	150	5	61394
CHIRALPAK® AZ-H	Semi-preparative	20	250	5	61345
CHIRALPAK® AZ-H	Semi-preparative	10	250	5	61335
CHIRALPAK® AZ-H	Guard/semi prep	10	20	5	61337
CHIRALPAK® AZ-H	Analytical	4.6	250	5	61325
CHIRALPAK® AZ-H	Analytical	4.6	150	5	61324
CHIRALPAK® AZ-H	Guard Cartridge ×3pcs	4	10	5	61311



# Normal Phase HPLC Columns

## CHIRALCEL® OD-3

		Internal Diameter(mm)	Column Length(mm)	Particle Size(μm)	Reference
CHIRALCEL® OD-3	Analytical	2.1	150	3	14594
CHIRALCEL® OD-3	Analytical	2.1	250	3	14595
CHIRALCEL® OD-3	Analytical	4.6	50	3	14522
CHIRALCEL® OD-3	Analytical	4.6	100	3	14523
CHIRALCEL® OD-3	Analytical	4.6	150	3	14524
CHIRALCEL® OD-3	Analytical	4.6	250	3	14525
CHIRALCEL® OD-3	Guard Cartridges <sup>※1</sup>	4	10	3	14511

※1 : 3pc/set (You need Cartridge Holder when using Guard Cartridge.)

## CHIRALCEL® OD-H

		Internal Diameter(mm)	Column Length(mm)	Particle Size(μm)	Reference
CHIRALCEL® OD-H	Analytical	2.1	150	5	14394
CHIRALCEL® OD-H	Analytical	2.1	250	5	14395
CHIRALCEL® OD-H	Analytical	4.6	150	5	14324
CHIRALCEL® OD-H	Analytical	4.6	250	5	14325
CHIRALCEL® OD-H	Guard Cartridges <sup>※1</sup>	4	10	5	14311
CHIRALCEL® OD-H	Semi-prep	10	250	5	14335
CHIRALCEL® OD-H	Semi-prep	20	250	5	14345
CHIRALCEL® OD-H	Guard column for Semi-prep	10	20	5	14337

※1 : 3pc/set (You need Cartridge Holder when using Guard Cartridge.)

## CHIRALCEL® OD

		Internal Diameter(mm)	Column Length(mm)	Particle Size(μm)	Reference
CHIRALCEL® OD	Analytical	4.6	250	10	14025
CHIRALCEL® OD	Guard column for Analytical	4.6	50	10	14022
CHIRALCEL® OD	Semi-prep	10	250	10	14035
CHIRALCEL® OD	Guard column for Semi-prep	10	50	10	14032
CHIRALCEL® OD	Semi-prep	20	250	10	14045
CHIRALCEL® OD	Guard column for Semi-prep	20	50	10	14042
CHIRALCEL® OD	Prep	50	500	20	14256
CHIRALCEL® OD	Guard column for Prep	50	100	20	14253

### CSP

Cellulose tris  
(3,5-dimethylphenylcarbamate)  
coated on silica gel

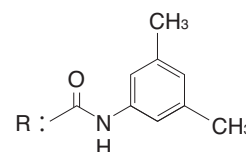
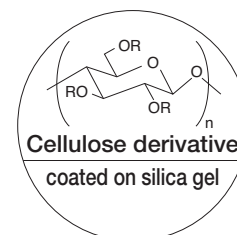

# CHIRALCEL® OJ-3

		Internal Diameter (mm)	Column Length (mm)	Particle Size (µm)	Reference
CHIRALCEL® OJ-3	Analytical	2.1	150	3	17594
CHIRALCEL® OJ-3	Analytical	2.1	250	3	17595
CHIRALCEL® OJ-3	Analytical	4.6	50	3	17522
CHIRALCEL® OJ-3	Analytical	4.6	100	3	17523
CHIRALCEL® OJ-3	Analytical	4.6	150	3	17524
CHIRALCEL® OJ-3	Analytical	4.6	250	3	17525
CHIRALCEL® OJ-3	Guard Cartridges <sup>※1</sup>	4	10	3	17511

※1 : 3pc/set (You need Cartridge Holder when using Guard Cartridge.)

# CHIRALCEL® OJ-H

		Internal Diameter (mm)	Column Length (mm)	Particle Size (µm)	Reference
CHIRALCEL® OJ-H	Analytical	2.1	150	5	17394
CHIRALCEL® OJ-H	Analytical	2.1	250	5	17395
CHIRALCEL® OJ-H	Analytical	4.6	150	5	17324
CHIRALCEL® OJ-H	Analytical	4.6	250	5	17325
CHIRALCEL® OJ-H	Guard Cartridges <sup>※1</sup>	4	10	5	17311
CHIRALCEL® OJ-H	Semi-prep	10	250	5	17335
CHIRALCEL® OJ-H	Semi-prep	20	250	5	17345
CHIRALCEL® OJ-H	Guard column for Semi-prep	10	20	5	17337

※1 : 3pc/set (You need Cartridge Holder when using Guard Cartridge.)

# CHIRALCEL® OJ

		Internal Diameter (mm)	Column Length (mm)	Particle Size (µm)	Reference
CHIRALCEL® OJ	Analytical	4.6	250	10	17025
CHIRALCEL® OJ	Guard column for Analytical	4.6	50	10	17022
CHIRALCEL® OJ	Semi-prep	10	250	10	17035
CHIRALCEL® OJ	Guard column for Semi-prep	10	50	10	17032
CHIRALCEL® OJ	Semi-prep	20	250	10	17045
CHIRALCEL® OJ	Guard column for Semi-prep	20	50	10	17042
CHIRALCEL® OJ	Prep	50	500	20	17256
CHIRALCEL® OJ	Guard column for Prep	50	100	20	17253

## CSP

Cellulose tris  
(4-methylbenzoate)  
coated on silica gel

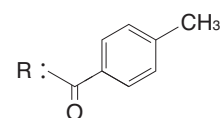
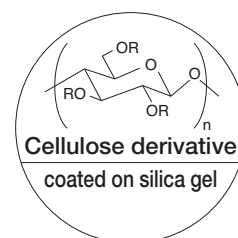

# Normal Phase HPLC Columns

## CHIRALCEL® OX-3

		Internal Diameter (mm)	Column Length (mm)	Particle Size (µm)	Reference
CHIRALCEL® OX-3	Analytical	2.1	250	3	63595
CHIRALCEL® OX-3	Analytical	2.1	150	3	63594
CHIRALCEL® OX-3	Analytical	4.6	250	3	63525
CHIRALCEL® OX-3	Analytical	4.6	150	3	63524
CHIRALCEL® OX-3	Analytical	4.6	100	3	63523
CHIRALCEL® OX-3	Analytical	4.6	50	3	63522
CHIRALCEL® OX-3	Guard Cartridge X3pcs	4	10	3	63511

### CSP

Cellulose tris  
(4-chloro-3-methylphenylcarbamate)  
coated on silica gel

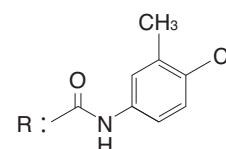
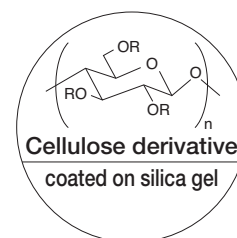

## CHIRALCEL® OX-H

		Internal Diameter (mm)	Column Length (mm)	Particle Size (µm)	Reference
CHIRALCEL® OX-H	Analytical	2.1	250	5	63395
CHIRALCEL® OX-H	Analytical	2.1	150	5	63394
CHIRALCEL® OX-H	Semi-preparative	20	250	5	63345
CHIRALCEL® OX-H	Semi-preparative	10	250	5	63335
CHIRALCEL® OX-H	Guard/semi prep	10	20	5	63337
CHIRALCEL® OX-H	Analytical	4.6	250	5	63325
CHIRALCEL® OX-H	Analytical	4.6	150	5	63324
CHIRALCEL® OX-H	Guard Cartridge X3pcs	4	10	5	63311





# CHIRALCEL® OZ-3

		Internal Diameter (mm)	Column Length (mm)	Particle Size (µm)	Reference
CHIRALCEL® OZ-3	Analytical	2.1	150	3	42594
CHIRALCEL® OZ-3	Analytical	2.1	250	3	42595
CHIRALCEL® OZ-3	Analytical	4.6	50	3	42522
CHIRALCEL® OZ-3	Analytical	4.6	100	3	42523
CHIRALCEL® OZ-3	Analytical	4.6	150	3	42524
CHIRALCEL® OZ-3	Analytical	4.6	250	3	42525
CHIRALCEL® OZ-3	Guard Cartridges <sup>※1</sup>	4	10	3	42511

※1 : 3pc/set (You need Cartridge Holder when using Guard Cartridge.)

# CHIRALCEL® OZ-H

		Internal Diameter (mm)	Column Length (mm)	Particle Size (µm)	Reference
CHIRALCEL® OZ-H	Analytical	2.1	150	5	42394
CHIRALCEL® OZ-H	Analytical	2.1	250	5	42395
CHIRALCEL® OZ-H	Analytical	4.6	150	5	42324
CHIRALCEL® OZ-H	Analytical	4.6	250	5	42325
CHIRALCEL® OZ-H	Guard Cartridges <sup>※1</sup>	4	10	5	42311
CHIRALCEL® OZ-H	Semi-prep	10	250	5	42335
CHIRALCEL® OZ-H	Semi-prep	20	250	5	42345
CHIRALCEL® OZ-H	Guard column for Semi-prep	10	20	5	42337

※1 : 3pc/set (You need Cartridge Holder when using Guard Cartridge.)

# CHIRALCEL® OA

		Internal Diameter (mm)	Column Length (mm)	Particle Size (µm)	Reference
CHIRALCEL® OA	Analytical	4.6	250	10	11025
CHIRALCEL® OA	Guard column for Analytical	4.6	50	10	11022

## CSP

Cellulose tris  
(3-chloro-4-methylphenylcarbamate)  
coated on silica gel

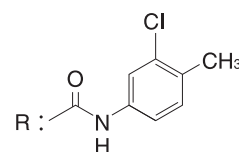
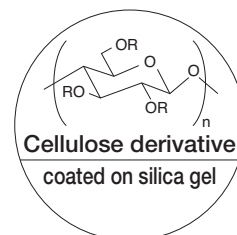

## CSP

Cellulose triacetate  
coated on silica gel

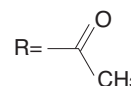
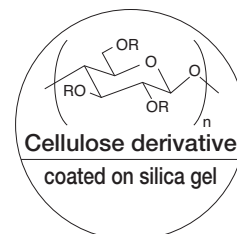

# Normal Phase HPLC Columns

## CHIRALCEL® OB-H

		Internal Diameter (mm)	Column Length (mm)	Particle Size (µm)	Reference
CHIRALCEL® OB-H	Analytical	2.1	150	5	12394
CHIRALCEL® OB-H	Analytical	2.1	250	5	12395
CHIRALCEL® OB-H	Analytical	4.6	150	5	12324
CHIRALCEL® OB-H	Analytical	4.6	250	5	12325
CHIRALCEL® OB-H	Guard Cartridges**1	4	10	5	12311

\*\*1 : 3pc/set (You need Cartridge Holder when using Guard Cartridge.)

## CHIRALCEL® OB

		Internal Diameter (mm)	Column Length (mm)	Particle Size (µm)	Reference
CHIRALCEL® OB	Analytical	4.6	250	10	12025
CHIRALCEL® OB	Guard column for Analytical	4.6	50	10	12022

### CSP

Cellulose tribenzoate  
coated on silica gel

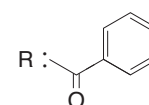
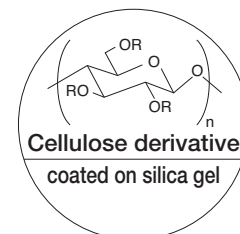

## CHIRALCEL® OC-H

		Internal Diameter (mm)	Column Length (mm)	Particle Size (µm)	Reference
CHIRALCEL® OC-H	Analytical	2.1	150	5	13394
CHIRALCEL® OC-H	Analytical	2.1	250	5	13395
CHIRALCEL® OC-H	Analytical	4.6	150	5	13324
CHIRALCEL® OC-H	Analytical	4.6	250	5	13325
CHIRALCEL® OC-H	Guard Cartridges**1	4	10	5	13311

\*\*1 : 3pc/set (You need Cartridge Holder when using Guard Cartridge.)

## CHIRALCEL® OC

		Internal Diameter (mm)	Column Length (mm)	Particle Size (µm)	Reference
CHIRALCEL® OC	Analytical	4.6	250	10	13025
CHIRALCEL® OC	Guard column for Analytical	4.6	50	10	13022

### CSP

Cellulose tris  
(phenylcarbamate)  
coated on silica gel

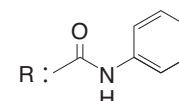
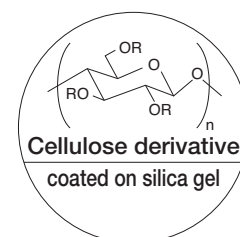

# CHIRALCEL® OF

		Internal Diameter (mm)	Column Length (mm)	Particle Size (µm)	Reference
CHIRALCEL® OF	Analytical	4.6	250	10	15025
CHIRALCEL® OF	Guard column for Analytical	4.6	50	10	15022
CHIRALCEL® OF	Semi-prep	10	250	10	15035
CHIRALCEL® OF	Guard column for Semi-prep	10	50	10	15032
CHIRALCEL® OF	Semi-prep	20	250	10	15045
CHIRALCEL® OF	Guard column for Semi-prep	20	50	10	15042

## CSP

Cellulose tris  
(4-chlorophenylcarbamate)  
coated on silica gel

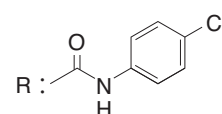
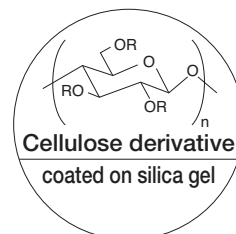

# CHIRALCEL® OG

		Internal Diameter (mm)	Column Length (mm)	Particle Size (µm)	Reference
CHIRALCEL® OG	Analytical	4.6	250	10	16025
CHIRALCEL® OG	Guard column for Analytical	4.6	50	10	16022

## CSP

Cellulose tris  
(4-methylphenylcarbamate)  
coated on silica gel

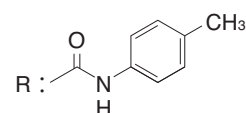
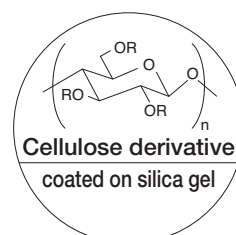

# CHIRALCEL® OK

		Internal Diameter (mm)	Column Length (mm)	Particle Size (µm)	Reference
CHIRALCEL® OK	Analytical	4.6	250	10	18025
CHIRALCEL® OK	Guard column for Analytical	4.6	50	10	18022

## CSP

Cellulose tricinnamate  
coated on silica gel

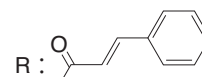
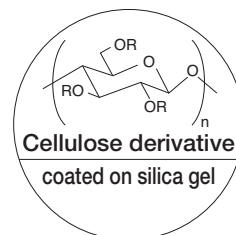

# Semi-Preparative Columns

If you consider the little amount of separation, we recommend our Semi-prep columns.

Easy to scale up from analytical to semi-preparative columns.

In case of the same length, the flow rate and injection volume are increased in proportion to the cross section area.

For example, in case of 20mm ID Semi-prep columns, you can inject twenty times of analytical column's maximum sample load.

$$X(\text{mg}) \times \left( \frac{10^2 \times \pi}{(2.3)^2 \times \pi} \right) \div X(\text{mg}) \times 20$$

X : Analytical column's maximum sample load.

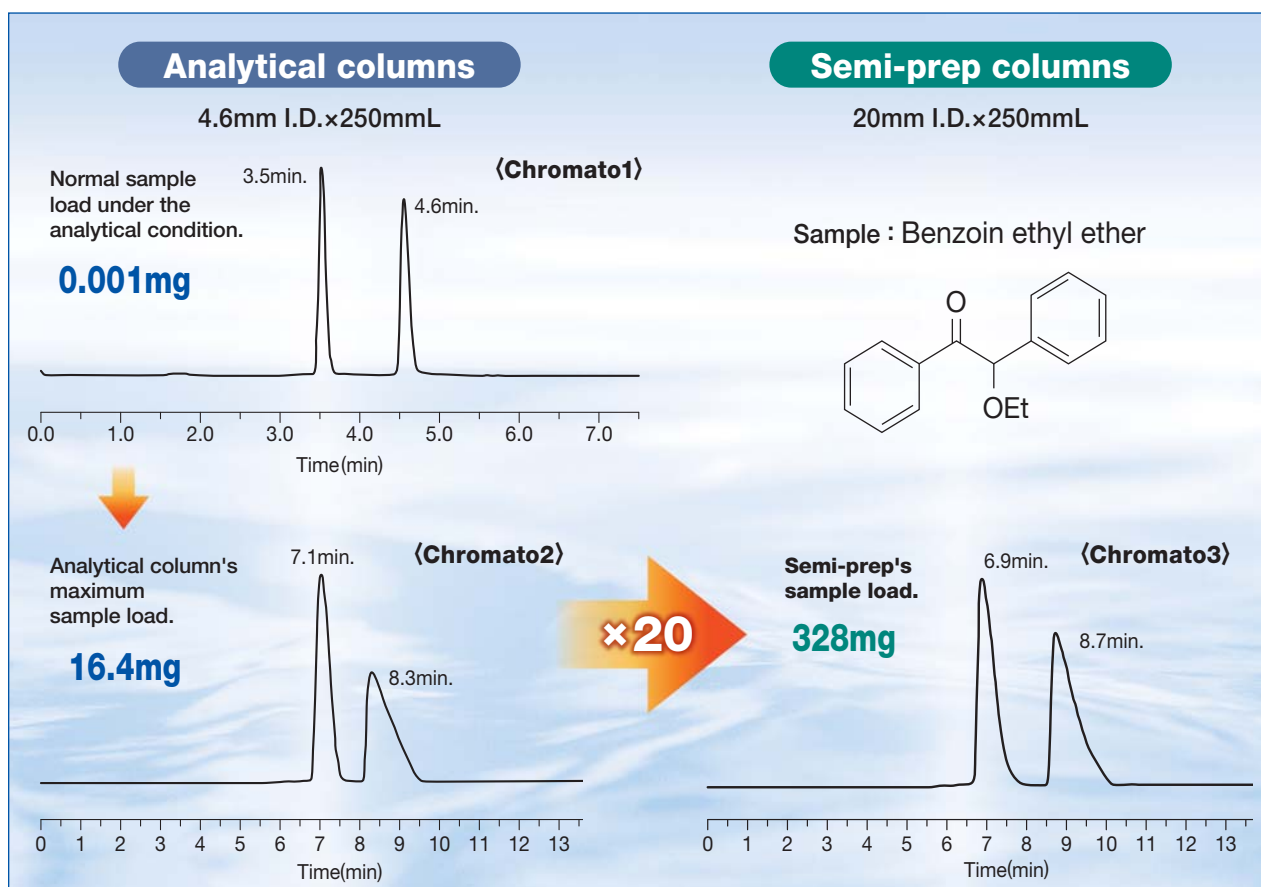

	Product	Size	Particle size	Mobile phase	Flow rate	Temp.	Detection wavelength	Sample temp.	Inj.	Sample load
Chromato1	CHIRALPAK® IA	4.6mm I.D. x 250mmL	5µm	Hexane/Ethyl acetate =40/60 (v/v)	1.0ml/min	40°C	254nm (UV)	1.0mg/ml (Mobile phase)	1.0µl	0.001mg
Chromato2	CHIRALPAK® IA	4.6mm I.D. x 250mmL	5µm	Hexane/Ethyl acetate =40/60 (v/v)	0.5ml/min	40°C	310nm (UV)	656mg/ml (Mobile phase)	25µl	16.4mg
Chromato3	CHIRALPAK® IA	20mm I.D. x 250mmL	5µm	Hexane/Ethyl acetate =40/60 (v/v)	9.4ml/min	40°C	310nm (UV)	656mg/ml (Mobile phase)	500µl	328mg

# Reverse Phase HPLC Columns

## Feature

- For reverse phase use
- You can analyze the optical purity of metabolic substance and sample which is produced by bio-method, under water-based mobile phase condition
- Available for LC/MS (we prepare 2.1mm ID products.)
- 3 micron type is available

## Mobile Phase

	Cellulose type	Amylose type
	<b>CHIRALCEL® OD-3R/OD-RH/OD-R</b> <b>CHIRALCEL® OJ-3R/OJ-RH</b> <b>CHIRALCEL® OZ-3R/OZ-RH</b>	<b>CHIRALPAK® AD-3R/AD-RH</b> <b>CHIRALPAK® AS-3R/AS-RH</b> <b>CHIRALPAK® AY-3R/AY-RH</b>
<b>Neutral</b>	Water / Acetonitrile = 60 / 40 (v/v)	
<b>Acidic</b>	HCOOH aqueous solution pH2.0 / Acetonitrile = 60 / 40 (v/v) H <sub>3</sub> PO <sub>4</sub> aqueous solution pH2.0 / Acetonitrile = 60 / 40 (v/v) 0.1M phosphate buffer (pH2) / Acetonitrile = 60 / 40 (v/v)	
<b>Basic</b>	20mM (NH <sub>4</sub> )HCO <sub>3</sub> aq. Soln. (pH9) <sup>*1</sup> / Acetonitrile = 60 / 40 (v/v)	
	0.1M KPF <sub>6</sub> aq. / Acetonitrile = 60 / 40 (v/v)	20mM borate buffer (pH9) / Acetonitrile = 60 / 40 (v/v)

\*1 : Please adjust the pH of solution to the value of 9 with Diethylamine.

Immobilized type chiral HPLC columns are applicable to the above mobile phases.

## Notice

The use of strong basic conditions (> pH 9) must be avoided, as they are known to damage the silica gel support used to make this stationary phase.

# Reverse Phase HPLC Columns

## CHIRALPAK® AD-3R

### Reverse phase mode of CHIRALPAK® AD-3

		Internal Diameter (mm)	Column Length (mm)	Particle Size (μm)	Reference
CHIRALPAK® AD-3R	Analytical	2.1	150	3	19894
CHIRALPAK® AD-3R	Analytical	4.6	50	3	19822
CHIRALPAK® AD-3R	Analytical	4.6	100	3	19823
CHIRALPAK® AD-3R	Analytical	4.6	150	3	19824
CHIRALPAK® AD-3R	Guard Cartridges**1	4	10	3	19811

\*\*1 : 3pc/set (You need Cartridge Holder when using Guard Cartridge.)

## CHIRALPAK® AD-RH

### Reverse phase mode of CHIRALPAK® AD-H

		Internal Diameter (mm)	Column Length (mm)	Particle Size (μm)	Reference
CHIRALPAK® AD-RH	Analytical	2.1	150	5	19794
CHIRALPAK® AD-RH	Analytical	4.6	150	5	19724
CHIRALPAK® AD-RH	Guard Cartridges**1	4	10	5	19711
CHIRALPAK® AD-RH	Semi-prep	20	150	5	19744

\*\*1 : 3pc/set (You need Cartridge Holder when using Guard Cartridge.)

## CHIRALPAK® AS-3R

### Reverse phase mode of CHIRALPAK® AS-3

		Internal Diameter (mm)	Column Length (mm)	Particle Size (μm)	Reference
CHIRALPAK® AS-3R	Analytical	2.1	150	3	20894
CHIRALPAK® AS-3R	Analytical	4.6	50	3	20822
CHIRALPAK® AS-3R	Analytical	4.6	100	3	20823
CHIRALPAK® AS-3R	Analytical	4.6	150	3	20824
CHIRALPAK® AS-3R	Guard Cartridges**1	4	10	3	20811

\*\*1 : 3pc/set (You need Cartridge Holder when using Guard Cartridge.)

## CHIRALPAK® AS-RH

### Reverse phase mode of CHIRALPAK® AS-H

		Internal Diameter (mm)	Column Length (mm)	Particle Size (μm)	Reference
CHIRALPAK® AS-RH	Analytical	2.1	150	5	20794
CHIRALPAK® AS-RH	Analytical	4.6	150	5	20724
CHIRALPAK® AS-RH	Guard Cartridges**1	4	10	5	20711
CHIRALPAK® AS-RH	Semi-prep	20	150	5	20744

\*\*1 : 3pc/set (You need Cartridge Holder when using Guard Cartridge.)

#### CSP

Amylose tris  
(3,5-dimethylphenylcarbamate)  
coated on silica gel

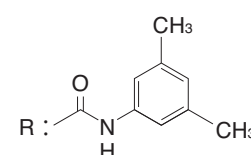
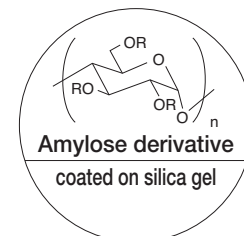

#### CSP

Amylose tris  
{ (S)-α-methylbenzylcarbamate }  
coated on silica gel

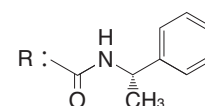
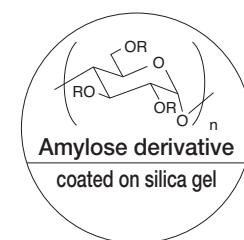

# CHIRALPAK® AY-3R

## Reverse phase mode of CHIRALPAK® AY-3

		Internal Diameter (mm)	Column Length (mm)	Particle Size (µm)	Reference
CHIRALPAK® AY-3R	Analytical	2.1	150	3	47894
CHIRALPAK® AY-3R	Analytical	4.6	50	3	47822
CHIRALPAK® AY-3R	Analytical	4.6	100	3	47823
CHIRALPAK® AY-3R	Analytical	4.6	150	3	47824
CHIRALPAK® AY-3R	Guard Cartridges <sup>※1</sup>	4	10	3	47811

※1 : 3pc/set (You need Cartridge Holder when using Guard Cartridge.)

# CHIRALPAK® AY-RH

## Reverse phase mode of CHIRALPAK® AY-H

		Internal Diameter (mm)	Column Length (mm)	Particle Size (µm)	Reference
CHIRALPAK® AY-RH	Analytical	2.1	150	5	47794
CHIRALPAK® AY-RH	Analytical	4.6	150	5	47724
CHIRALPAK® AY-RH	Guard Cartridges <sup>※1</sup>	4	10	5	47711
CHIRALPAK® AY-RH	Semi-prep	20	150	5	47744

※1 : 3pc/set (You need Cartridge Holder when using Guard Cartridge.)

# CHIRALPAK® AZ-3R

## Reverse phase mode of CHIRALPAK® AZ-3

		Internal Diameter (mm)	Column Length (mm)	Particle Size (µm)	Reference
CHIRALPAK® AZ-3R	Analytical	4.6	150	3	61824
CHIRALPAK® AZ-3R	Analytical	4.6	100	3	61823
CHIRALPAK® AZ-3R	Analytical	4.6	50	3	61822
CHIRALPAK® AZ-3R	Analytical	2.1	150	3	61894
CHIRALPAK® AZ-3R	Guard cartridge ×3pcs	4	10	3	61811

# CHIRALPAK® AZ-RH

## Reverse phase mode of CHIRALPAK® AZ-H

		Internal Diameter (mm)	Column Length (mm)	Particle Size (µm)	Reference
CHIRALPAK® AZ-RH	Semi-preparative	20	150	5	61744
CHIRALPAK® AZ-RH	Analytical	2.1	150	5	61794
CHIRALPAK® AZ-RH	Analytical	4.6	150	5	61724
CHIRALPAK® AZ-RH	Guard Cartridge ×3pcs	4	10	5	61711

### CSP

Amylose tris  
(5-chloro-2-methylphenylcarbamate)  
coated on silica gel

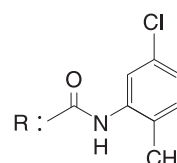
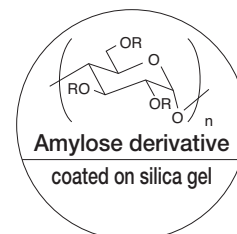

### CSP

Amylose tris  
(3-chloro-4-methylphenylcarbamate)  
coated on silica gel

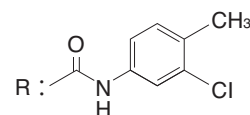
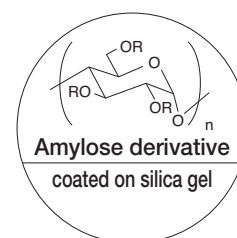

# Reverse Phase HPLC Columns

## CHIRALCEL® OD-3R

### Reverse phase mode of CHIRALCEL® OD-3

		Internal Diameter (mm)	Column Length (mm)	Particle Size (µm)	Reference
CHIRALCEL® OD-3R	Analytical	2.1	150	3	14894
CHIRALCEL® OD-3R	Analytical	4.6	50	3	14822
CHIRALCEL® OD-3R	Analytical	4.6	100	3	14823
CHIRALCEL® OD-3R	Analytical	4.6	150	3	14824
CHIRALCEL® OD-3R	Guard Cartridges <sup>※1</sup>	4	10	3	14811

※1 : 3pc/set (You need Cartridge Holder when using Guard Cartridge.)

## CHIRALCEL® OD-RH

### Reverse phase mode of CHIRALCEL® OD-H

		Internal Diameter (mm)	Column Length (mm)	Particle Size (µm)	Reference
CHIRALCEL® OD-RH	Analytical	2.1	150	5	14794
CHIRALCEL® OD-RH	Analytical	4.6	150	5	14724
CHIRALCEL® OD-RH	Guard Cartridges <sup>※1</sup>	4	10	5	14711
CHIRALCEL® OD-RH	Semi-prep	20	150	5	14744

※1 : 3pc/set (You need Cartridge Holder when using Guard Cartridge.)

## CHIRALCEL® OD-R

### Reverse phase mode of CHIRALCEL® OD

		Internal Diameter (mm)	Column Length (mm)	Particle Size (µm)	Reference
CHIRALCEL® OD-R	Analytical	4.6	250	10	14625
CHIRALCEL® OD-R	Guard Cartridges <sup>※1</sup>	4	10	10	14611

※1 : 3pc/set (You need Cartridge Holder when using Guard Cartridge.)

## CHIRALCEL® OJ-3R

### Reverse phase mode of CHIRALCEL® OJ-3

		Internal Diameter (mm)	Column Length (mm)	Particle Size (µm)	Reference
CHIRALCEL® OJ-3R	Analytical	2.1	150	3	17894
CHIRALCEL® OJ-3R	Analytical	4.6	50	3	17822
CHIRALCEL® OJ-3R	Analytical	4.6	100	3	17823
CHIRALCEL® OJ-3R	Analytical	4.6	150	3	17824
CHIRALCEL® OJ-3R	Guard Cartridges <sup>※1</sup>	4	10	3	17811

※1 : 3pc/set (You need Cartridge Holder when using Guard Cartridge.)

## CHIRALCEL® OJ-RH

### Reverse phase mode of CHIRALCEL® OJ-H

		Internal Diameter (mm)	Column Length (mm)	Particle Size (µm)	Reference
CHIRALCEL® OJ-RH	Analytical	2.1	150	5	17794
CHIRALCEL® OJ-RH	Analytical	4.6	150	5	17724
CHIRALCEL® OJ-RH	Guard Cartridges <sup>※1</sup>	4	10	5	17711
CHIRALCEL® OJ-RH	Semi-prep	20	150	5	17744

※1 : 3pc/set (You need Cartridge Holder when using Guard Cartridge.)

#### CSP

Cellulose tris  
(3,5-dimethylphenylcarbamate)  
coated on silica gel

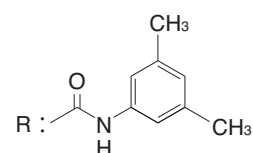
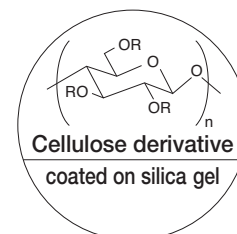

#### CSP

Cellulose tris  
(4-methylbenzoate)  
coated on silica gel

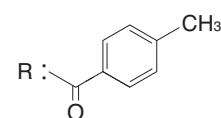
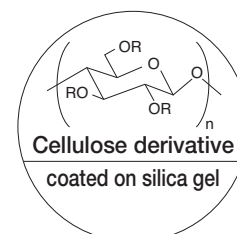



# CHIRALCEL® OX-3R

## Reverse phase mode of CHIRALCEL® OX-3

		Internal Diameter(mm)	Column Length(mm)	Particle Size(μm)	Reference
CHIRALCEL® OX-3R	Analytical	4.6	150	3	63824
CHIRALCEL® OX-3R	Analytical	4.6	100	3	63823
CHIRALCEL® OX-3R	Analytical	4.6	50	3	63822
CHIRALCEL® OX-3R	Analytical	2.1	150	3	63894
CHIRALCEL® OX-3R	Guard cartridge ×3pcs	4	10	3	63811

# CHIRALCEL® OX-RH

## Reverse phase mode of CHIRALCEL® OX-H

		Internal Diameter(mm)	Column Length(mm)	Particle Size(μm)	Reference
CHIRALCEL® OX-RH	Semi-preparative	20	150	5	63744
CHIRALCEL® OX-RH	Analytical	2.1	150	5	63794
CHIRALCEL® OX-RH	Analytical	4.6	150	5	63724
CHIRALCEL® OX-RH	Guard Cartridge ×3pcs	4	10	5	63711

# CHIRALCEL® OZ-3R

## Reverse phase mode of CHIRALCEL® OZ-3

		Internal Diameter(mm)	Column Length(mm)	Particle Size(μm)	Reference
CHIRALCEL® OZ-3R	Analytical	2.1	150	3	42894
CHIRALCEL® OZ-3R	Analytical	4.6	50	3	42822
CHIRALCEL® OZ-3R	Analytical	4.6	100	3	42823
CHIRALCEL® OZ-3R	Analytical	4.6	150	3	42824
CHIRALCEL® OZ-3R	Guard Cartridges <sup>※1</sup>	4	10	3	42811

※1 : 3pc/set (You need Cartridge Holder when using Guard Cartridge.)

# CHIRALCEL® OZ-RH

## Reverse phase mode of CHIRALCEL® OZ-H

		Internal Diameter(mm)	Column Length(mm)	Particle Size(μm)	Reference
CHIRALCEL® OZ-RH	Analytical	2.1	150	5	42794
CHIRALCEL® OZ-RH	Analytical	4.6	150	5	42724
CHIRALCEL® OZ-RH	Guard Cartridges <sup>※1</sup>	4	10	5	42711
CHIRALCEL® OZ-RH	Semi-prep	20	150	5	42744

※1 : 3pc/set (You need Cartridge Holder when using Guard Cartridge.)

### CSP

Cellulose tris  
(4-chloro-3-methylphenylcarbamate)  
coated on silica gel

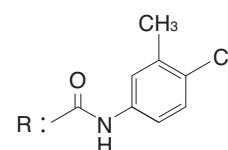
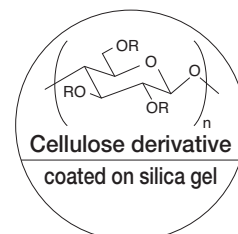

### CSP

Cellulose tris  
(3-chloro-4-methylphenylcarbamate)  
coated on silica gel

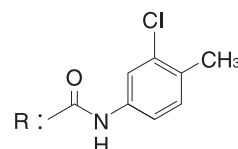
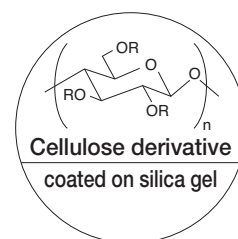

# Protein-based Chiral HPLC Columns

## Feature

**CHIRALPAK AGP® has extremely broad applicability for the separation of chiral drugs.**

**Basic compounds** : CHIRALPAK AGP®, CHIRALPAK CBH

**Acids, Non-protolytic compounds** : CHIRALPAK AGP®, CHIRALPAK HSA

- CHIRALPAK AGP® has extremely broad applicability for the separation of chiral drugs.
- The protein-based columns function entirely in the reversed-phase chromatographic mode, using buffers with low organic modifier content and at moderate pH values.
- Possibility to dynamically improve enantioseparation.

### CHIRALPAK AGP®

- The chiral selector is alpha1-acid glycoprotein (AGP). This very stable protein is immobilized onto spherical 5 micrometer silica particles. The CHIRALPAK AGP® column separates enantiomers of an extremely broad range of drug compounds.
  - Amines (primary, secondary, and tertiary)
  - Acids (strong and weak)
  - Nonprotolytes (amides, esters, alcohols, sulfoxides, etc.)

### CHIRALPAK CBH

- The chiral selector is Cellobiohydrolase (CBH). This is a stable enzyme, which has been immobilized onto 5 micrometer spherical silica particles.
- CHIRALPAK CBH is used for the separation of enantiomers of basic drugs from many compound classes. CHIRALPAK CBH separates preferentially compounds containing one or more basic nitrogen's together with one or more hydrogen accepting or hydrogen donating groups (alcohol, phenol, carbonyl, amide, ether, sulphoxide, ester etc.)

### CHIRALPAK HSA

- The chiral selector is human serum albumin (HSA). The protein has been immobilized onto spherical 5 micrometer particles.
- CHIRALPAK HSA is especially suited for the separation of weak and strong acids, zwitterionic and nonprotolytic compounds.

### Application

	ACIDS	NON-PROTOLYTES	BASIC
CHIRALPAK AGP®	←—————→		
CHIRALPAK CBH			←————→
CHIRALPAK HSA	←————→		

# CHIRALPAK AGP®

		Internal Diameter (mm)	Column Length (mm)	Particle Size (µm)	Reference
CHIRALPAK AGP®	Analytical	2	50	5	30792
CHIRALPAK AGP®	Analytical	2	100	5	30793
CHIRALPAK AGP®	Analytical	2	150	5	30794
CHIRALPAK AGP®	Guard Cartridges <sup>※1</sup>	2	10	5	30791
CHIRALPAK AGP®	Analytical	3	50	5	30782
CHIRALPAK AGP®	Analytical	3	100	5	30783
CHIRALPAK AGP®	Analytical	3	150	5	30784
CHIRALPAK AGP®	Guard Cartridges <sup>※1</sup>	3	10	5	30781
CHIRALPAK AGP®	Analytical	4	50	5	30712
CHIRALPAK AGP®	Analytical	4	100	5	30713
CHIRALPAK AGP®	Analytical	4	150	5	30714
CHIRALPAK AGP®	Guard Cartridges <sup>※1</sup>	4	10	5	30711
CHIRALPAK AGP®	Semi-prep	10	100	5	30733
CHIRALPAK AGP®	Semi-prep	10	150	5	30734

※1 : 2pc/set (You need the Guard Cartridge Holder especially for CHROMTECH type, when using the guard cartridge.)

## Accessory

		Reference
CHIRALPAK AGP® Guard cartridge holder	Guard cartridge holder for AGP	00081

※This guard cartridge holder for AGP is applicable to all of ID (2mm, 3mm, and 4mm) .



# Protein-based Chiral HPLC Columns

## CHIRALPAK CBH

		Internal Diameter (mm)	Column Length (mm)	Particle Size (µm)	Reference
CHIRALPAK CBH	Analytical	2	50	5	33792
CHIRALPAK CBH	Analytical	2	100	5	33793
CHIRALPAK CBH	Analytical	2	150	5	33794
CHIRALPAK CBH	Guard Cartridges <sup>※1</sup>	2	10	5	33791
CHIRALPAK CBH	Analytical	3	50	5	33782
CHIRALPAK CBH	Analytical	3	100	5	33783
CHIRALPAK CBH	Analytical	3	150	5	33784
CHIRALPAK CBH	Guard Cartridges <sup>※1</sup>	3	10	5	33781
CHIRALPAK CBH	Analytical	4	50	5	33712
CHIRALPAK CBH	Analytical	4	100	5	33713
CHIRALPAK CBH	Analytical	4	150	5	33714
CHIRALPAK CBH	Guard Cartridges <sup>※1</sup>	4	10	5	33711
CHIRALPAK CBH	Semi-prep	10	100	5	33733
CHIRALPAK CBH	Semi-prep	10	150	5	33734

※1 : 2pc/set (You need the Guard Cartridge Holder especially for CHROMTECH type, when using the guard cartridge.)

## CHIRALPAK HSA

		Internal Diameter (mm)	Column Length (mm)	Particle Size (µm)	Reference
CHIRALPAK HSA	Analytical	2	50	5	34792
CHIRALPAK HSA	Analytical	2	100	5	34793
CHIRALPAK HSA	Analytical	2	150	5	34794
CHIRALPAK HSA	Guard Cartridges <sup>※1</sup>	2	10	5	34791
CHIRALPAK HSA	Analytical	3	50	5	34782
CHIRALPAK HSA	Analytical	3	100	5	34783
CHIRALPAK HSA	Analytical	3	150	5	34784
CHIRALPAK HSA	Guard Cartridges <sup>※1</sup>	3	10	5	34781
CHIRALPAK HSA	Analytical	4	50	5	34712
CHIRALPAK HSA	Analytical	4	100	5	34713
CHIRALPAK HSA	Analytical	4	150	5	34714
CHIRALPAK HSA	Guard Cartridges <sup>※1</sup>	4	10	5	34711
CHIRALPAK HSA	Semi-prep	10	100	5	34733
CHIRALPAK HSA	Semi-prep	10	150	5	34734

※1 : 2pc/set (You need the Guard Cartridge Holder especially for CHROMTECH type, when using the guard cartridge.)

# DAICEL Chiral HPLC Columns for Special Applications

## Crown Ether Chiral Stationary Phases

### CROWNPAK® CR(+)/CR(-) columns

These columns contain a chiral crown ether as a chiral selector which is coated onto a 5µm silica support. Acidic mobile phases such as Perchloric acid pH 1 to 2, are used to operate these columns under standard conditions. Note that to shorten the retention time of hydrophobic samples, the addition of Methanol (15% maximum v/v) has been shown to be effective. These columns are the reference columns for achieving amino acid separations, with the advantage that the elution order of the enantiomers can be reversed when necessary (CR(-) column gives the reversed elution order compared to CR(+) column).

#### Separation compounds

Amino acid	Amino alcohol	Amines
------------	---------------	--------

## Anion Exchange Chiral Stationary Phases

### CHIRALPAK® QN-AX/QD-AX columns

These columns are enantioselective weak anion-exchange (AX) HPLC columns. They were developed by Prof. W. Kindber's group in Viena and are designed specifically for enantioselective HPLC of chiral acids and possess exceptional enantiomer separation capabilities for acidic chiral compounds containing carboxylic, phosphoric, phosphoric or sulfonic acid groups. In some cases, weakly acidic compounds such as phenols can also be separated.

#### Separation compounds

N-derivatised amino acids	Aryloxy-carboxylic acids
Aminosulfonic acids	N-derivatised peptides
Aminophosphonic acids	

## Ligand Exchange Chiral Stationary Phases

### CHIRALPAK® WH/CHIRALPAK® MA(+) columns

The chiral stationary phases in these columns are made of amino acids and its derivatives coated or bonded to silica supports (with a particle size of 10µm for WH and 3µm for MA (+)). Since these columns are ligand-exchange type columns, the standard mobile phase to use is an aqueous solution of CuSO<sub>4</sub> (0.1 to 2mM). These columns can tolerate organic modifiers such as Methanol and Acetonitrile according to the specifications in the instruction manual.

#### Separation compounds

Amino acids and amino acid derivatives
Hydroxycarbonic acids

## Polymethacrylate Chiral Stationary Phases

### CHIRALPAK® OP(+)/CHIRALPAK® OT(+) columns

The chiral selector is a chiral synthetic methacrylate polymer coated onto a 10µm silica support. The best chromatographic results are obtained using 100% Methanol as mobile phase. The polymer used for the CHIRALPAK OT (+) column is very delicate and is slowly degraded by alcohols. To avoid this phenomenon, we recommend to run the analyses at low temperatures (0~5).

# DAICEL Chiral HPLC Columns for Special Applications

## CROWNPAK® CR(+)/CR(-)

Crown Ether Chiral Stationary Phase Analytical columns for HPLC

		Internal Diameter(mm)	Column Length(mm)	Particle Size(μm)	Reference
CROWNPAK® CR(+)	Analytical	4	150	5	27714
CROWNPAK® CR(+)	Semi-prep	10	150	5	27734
CROWNPAK® CR(-)	Analytical	4	150	5	28714
CROWNPAK® CR(-)	Semi-prep	10	150	5	28734
CROWNPAK® CR	Guard column for Analytical <sup>※1</sup>	4	10	5	27711

※1 : Guard column is applicable for both CROWNPAK CR(+) and CR(-).

CSP

CR (+) : (S)-18-crown-6 ether coated on silica gel

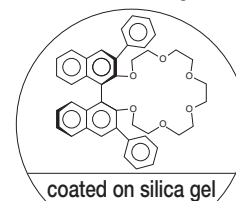

CR(+)

CR (-) : (R)-18-crown-6 ether coated on silica gel

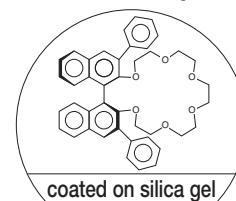

CR(-)

## CHIRALPAK® QN-AX/QD-AX

Anion Exchange Chiral Stationary Phases Analytical and Semi-prep columns for HPLC

		Internal Diameter(mm)	Column Length(mm)	Particle Size(μm)	Reference
CHIRALPAK® QN-AX	Analytical	4.6	150	5	32324
CHIRALPAK® QN-AX	Guard Cartridges <sup>※1</sup>	4	10	5	32311
CHIRALPAK® QN-AX	Analytical	2.1	150	5	32394
CHIRALPAK® QN-AX	Semi-prep	20	150	5	32344

		Internal Diameter(mm)	Column Length(mm)	Particle Size(μm)	Reference
CHIRALPAK® QD-AX	Analytical	4.6	150	5	31324
CHIRALPAK® QD-AX	Guard Cartridges <sup>※1</sup>	4	10	5	31311
CHIRALPAK® QD-AX	Analytical	2.1	150	5	31394
CHIRALPAK® QD-AX	Semi-prep	20	150	5	31344

※1 : 3pc/set (You need Cartridge Holder when using Guard Cartridge.)

CSP

CHIRALPAK QN-AX: (8S,9R)  
CHIRALPAK QD-AX: (8R,9S)

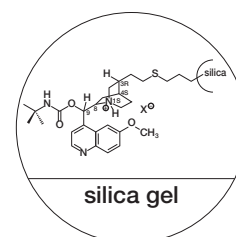

# CHIRALPAK® WH

## Ligand Exchange Chiral Stationary Phases

		Internal Diameter (mm)	Column Length (mm)	Particle Size (µm)	Reference
CHIRALPAK® WH	Analytical	4.6	250	10	25625
CHIRALPAK® WH	Guard column for Analytical	4.6	50	10	25622

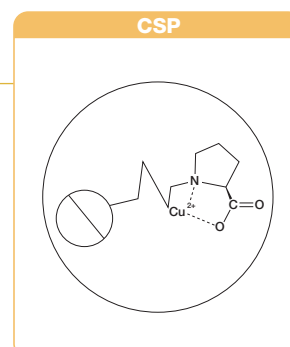

# CHIRALPAK® MA(+)

## Ligand Exchange Chiral Stationary Phases

		Internal Diameter (mm)	Column Length (mm)	Particle Size (µm)	Reference
CHIRALPAK® MA(+)	Analytical	4.6	50	3	21822

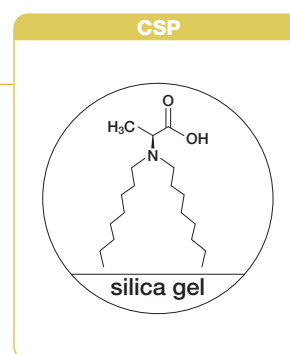

# CHIRALPAK® OP(+)/OT(+)

## Polymethacrylate Chiral Stationary Phases

		Internal Diameter (mm)	Column Length (mm)	Particle Size (µm)	Reference
CHIRALPAK® OP(+)	Analytical	4.6	250	10	22025
CHIRALPAK® OP(+)	Guard column for Analytical	4.6	50	10	22022

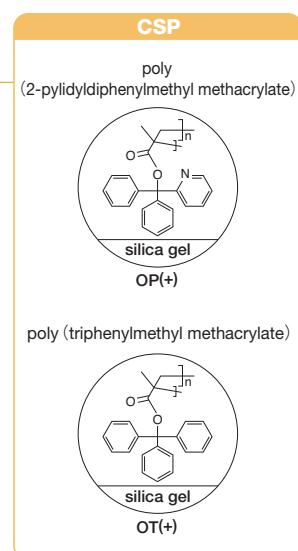

		Internal Diameter (mm)	Column Length (mm)	Particle Size (µm)	Reference
CHIRALPAK® OT(+)	Analytical	4.6	250	10	23025
CHIRALPAK® OT(+)	Guard column for Analytical	4.6	50	10	23022

# Analytical Chromatography Accessories

## Guard Cartridge Holder

The HPLC analytical guard cartridges need to be mounted in a cartridge holder to be connected to the analytical column.

For maximum lifetime, analytical columns should be used in series with an appropriate guard cartridge or column.

Both formats are available with the packing material to match the protected column.

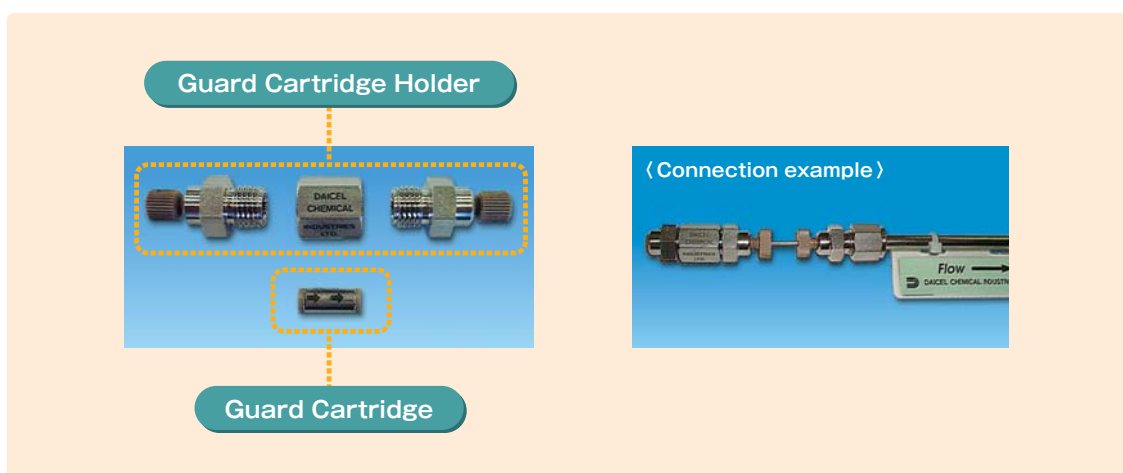

- We prepare Guard columns (Analytical & Semi-prep) for CHIRALPAK® AD/AS/OP(+)/OT(+), CHIRALCEL® OA/OB/OC/OD/OF/OG/OJ/OK.

	Internal Diameter (mm)	Column Length (mm)	Particle Size (μm)	Reference
Guard Cartridge Holder	4	10	-	00011

## Column Jacket

Column jackets allow operating temperatures of analytical columns to be controlled with a circulating water bath.

	Internal Diameter (mm)	Column Length (mm)	Particle Size (μm)	Reference
Column Jacket	-	150	-	00024
Column Jacket	-	250	-	00025



# SFC Chiral Columns

## Feature

### Supercritical Fluid Chromatography (SFC) :

When a material is in a state that the temperature and the pressure exceed the critical point, it becomes a supercritical fluid. In this phase, the density of gas and liquid becomes same. Super critical fluid is a special phase which has either gas and liquid character but different from these.

- **Low viscosity : Quick separation with low pressure drop.**
- **High diffusivity : High unit productivity.**
- **Low solvent consumption : Environmental friendly. CO<sub>2</sub> can be recycled.**
- **Acidic behavior of CO<sub>2</sub> : No additive such as TFA is required.**

## CHIRALPAK® IA/SFC

		Internal Diameter (mm)	Column Length (mm)	Particle Size (μm)	Reference
CHIRALPAK® IA/SFC	Analytical	4.6	250	5	80425
CHIRALPAK® IA/SFC	Semi-prep	10	250	5	80435
CHIRALPAK® IA/SFC	Semi-prep	20	250	5	80445

## CHIRALPAK® IB/SFC

		Internal Diameter (mm)	Column Length (mm)	Particle Size (μm)	Reference
CHIRALPAK® IB/SFC	Analytical	4.6	250	5	81425
CHIRALPAK® IB/SFC	Semi-prep	10	250	5	81435
CHIRALPAK® IB/SFC	Semi-prep	20	250	5	81445

## CHIRALPAK® IC/SFC

		Internal Diameter (mm)	Column Length (mm)	Particle Size (μm)	Reference
CHIRALPAK® IC/SFC	Analytical	4.6	250	5	83425
CHIRALPAK® IC/SFC	Semi-prep	10	250	5	83435
CHIRALPAK® IC/SFC	Semi-prep	20	250	5	83445

# SFC Chiral Columns

## CHIRALPAK® AD-H/SFC

		Internal Diameter (mm)	Column Length (mm)	Particle Size (µm)	Reference
CHIRALPAK® AD-H/SFC	Analytical	4.6	250	5	19425
CHIRALPAK® AD-H/SFC	Semi-prep	10	250	5	19435
CHIRALPAK® AD-H/SFC	Semi-prep	20	250	5	19445

## CHIRALPAK® AS-H/SFC

		Internal Diameter (mm)	Column Length (mm)	Particle Size (µm)	Reference
CHIRALPAK® AS-H/SFC	Analytical	4.6	250	5	20425
CHIRALPAK® AS-H/SFC	Semi-prep	10	250	5	20435
CHIRALPAK® AS-H/SFC	Semi-prep	20	250	5	20445

## CHIRALPAK® AY-H/SFC

		Internal Diameter (mm)	Column Length (mm)	Particle Size (µm)	Reference
CHIRALPAK® AY-H/SFC	Analytical	4.6	250	5	47425
CHIRALPAK® AY-H/SFC	Semi-prep	10	250	5	47435
CHIRALPAK® AY-H/SFC	Semi-prep	20	250	5	47445

## CHIRALCEL® OD-H/SFC

		Internal Diameter (mm)	Column Length (mm)	Particle Size (µm)	Reference
CHIRALCEL® OD-H/SFC	Analytical	4.6	250	5	14425
CHIRALCEL® OD-H/SFC	Semi-prep	10	250	5	14435
CHIRALCEL® OD-H/SFC	Semi-prep	20	250	5	14445

## CHIRALCEL® OJ-H/SFC

		Internal Diameter (mm)	Column Length (mm)	Particle Size (µm)	Reference
CHIRALCEL® OJ-H/SFC	Analytical	4.6	250	5	17425
CHIRALCEL® OJ-H/SFC	Semi-prep	10	250	5	17435
CHIRALCEL® OJ-H/SFC	Semi-prep	20	250	5	17445

## CHIRALCEL® OZ-H/SFC

		Internal Diameter (mm)	Column Length (mm)	Particle Size (µm)	Reference
CHIRALCEL® OZ-H/SFC	Analytical	4.6	250	5	42425
CHIRALCEL® OZ-H/SFC	Semi-prep	10	250	5	42435
CHIRALCEL® OZ-H/SFC	Semi-prep	20	250	5	42445

## CHIRALPAK® ID/SFC

		Internal Diameter (mm)	Column Length (mm)	Particle Size (µm)	Reference
CHIRALPAK® ID/SFC	Semi-prep	10	250	5	84435
CHIRALPAK® ID/SFC	Semi-prep	20	250	5	84445

## CHIRALPAK® IE/SFC

		Internal Diameter (mm)	Column Length (mm)	Particle Size (µm)	Reference
CHIRALPAK® IE/SFC	Semi-prep	10	250	5	85435
CHIRALPAK® IE/SFC	Semi-prep	20	250	5	85445

## CHIRALPAK® IF/SFC

		Internal Diameter (mm)	Column Length (mm)	Particle Size (µm)	Reference
CHIRALPAK® IF/SFC	Semi-prep	10	250	5	86435
CHIRALPAK® IF/SFC	Semi-prep	20	250	5	86445

## CHIRALPAK® AZ-H/SFC

		Internal Diameter (mm)	Column Length (mm)	Particle Size (µm)	Reference
CHIRALPAK® AZ-H/SFC	Semi-prep	10	250	5	61435
CHIRALPAK® AZ-H/SFC	Semi-prep	20	250	5	61445

## CHIRALCEL® OX-H/SFC

		Internal Diameter (mm)	Column Length (mm)	Particle Size (µm)	Reference
CHIRALCEL® OX-H/SFC	Semi-prep	10	250	5	63435
CHIRALCEL® OX-H/SFC	Semi-prep	20	250	5	63445

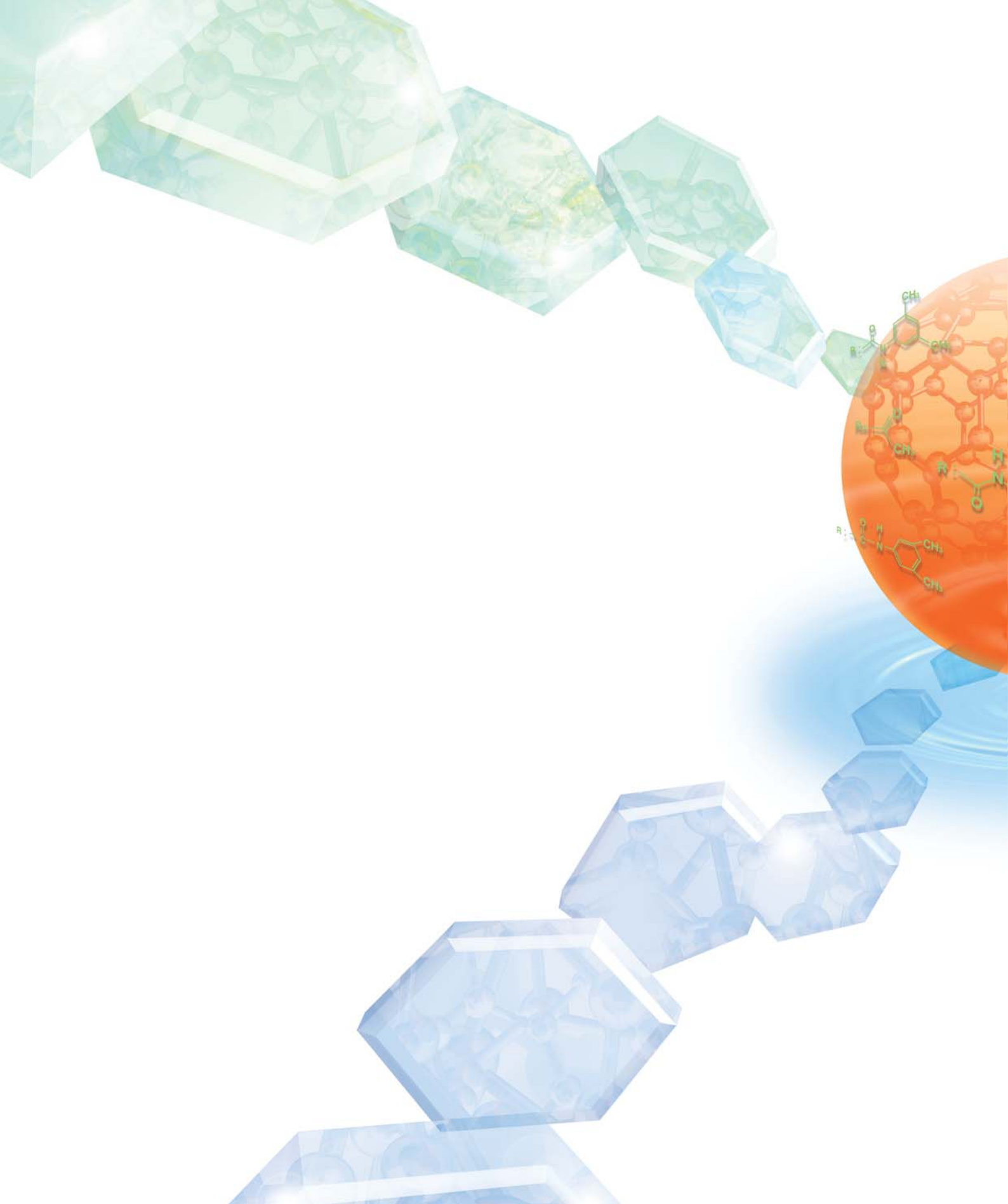

  
**DAICEL CORPORATION**

JR SHINAGAWWA EAST BLDG. 2-18-1, Konan, Minato-ku, Tokyo 108-8230, Japan  
TEL: +81-(0)3-6711-8222, FAX: +81-(0)3-6711-8228

● <http://www.daicelchiral.com/en/> ● E-mail: [chiral@jp.daicel.com](mailto:chiral@jp.daicel.com)

**DAICEL (ASIA) Pte, Ltd.**

78 Shenton Way #15-01/01B, Singapore 079120  
TEL: +65-6327-2038, FAX: +65-6327-2048

**DAICEL CHIRAL TECHNOLOGIES(CHINA) CO., LTD.**

Part C, FL5 No.16, Xiya Road No.69, Waigaoqiao Free  
Trade Zone, Shanghai, 200131, China  
TEL: +86-21-5046-0086, FAX: +86-21-5046-2321

● <http://www.daicelchina.com/>  
● E-mail: [guo.wr@ctc.daicel.com](mailto:guo.wr@ctc.daicel.com)

**DAICEL CHIRAL TECHNOLOGIES(INDIA) PVT., LTD.**

Laboratory No. 4A, Innovation Corridor 1, Phase III,  
ICICI Knowledge Park, Turkapally Village, Shameerpet Mandal,  
Ranga Reddy District, Hyderabad -500 078, INDIA  
TEL: +91-40-2348-0103, FAX: +91-40-2348-0104

● E-mail: [chiral@chiral.daicel.com](mailto:chiral@chiral.daicel.com)